

Metso:Outotec

Application guide

Nordberg® NP Series™ impact crusher wear parts

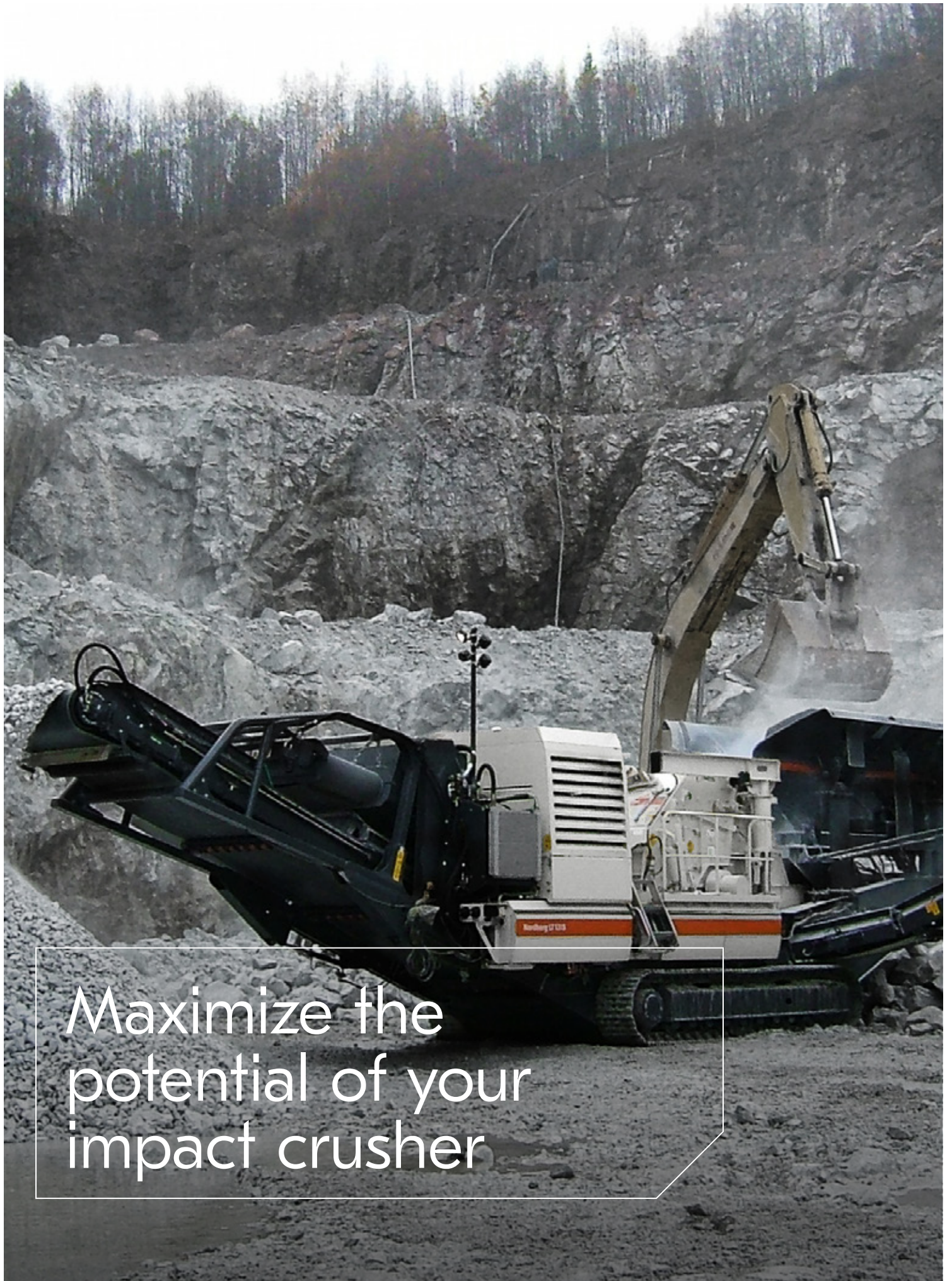



Maximize the
potential of your
impact crusher



Contents

Nordberg® NP Series™ impact crusher

NP Series™ impact crusher basic concepts	4
How to operate an NP Series™ impact crusher	6
Wear parts selection	7
Metso Outotec liners	8
Metso Outotec blow bars	9
Blow bar material selection	10
When to change wear parts	12
How to change wear parts	13
Maintenance tools	14



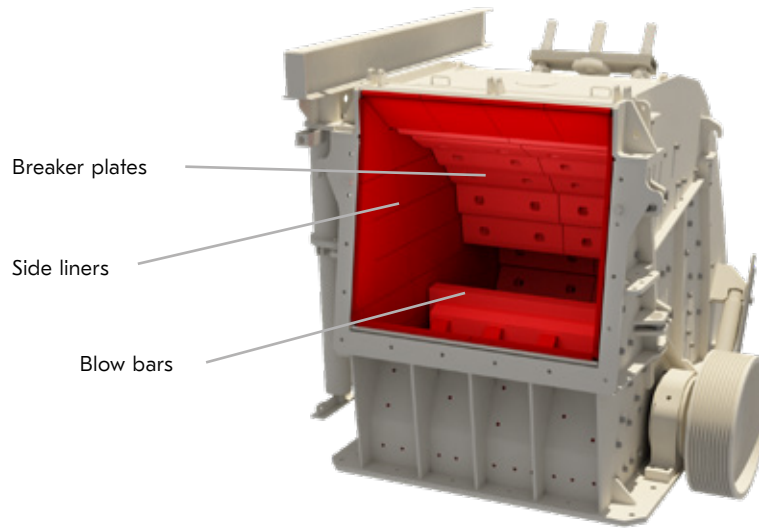

NP Series™ impact crusher basic concepts

There are many different feed materials, and they all have their own characteristics. Some are easy to crush, some disintegrate into powder, and some are very abrasive. For this reason, there are different types of crushers to accommodate the different materials and applications.

In compression crushing (primary gyratory, jaw crusher and cone crusher) the material is squeezed between two surfaces that move towards each other. The speed of the crushing movement is between 0.5-1.5 m/s.

In impact crushing (Horizontal Shaft Impactor – HSI, Vertical Shaft Impactor – VSI) the material is subjected to impacts from rotating parts (rotor equipped with blow bars, etc.) and thrown against metal surfaces. The movement speed is from 30-80 m/s.

- Good shape of end product
- Low initial investment
- High reduction ratio

Feed material is reduced by:

- Initial impact with blow bar (60%)
- Impact with breaker plates (30%)
- Inter-particle collisions

NP Series™ model	Feed opening	Maximum feed size	Maximum installed power
NP13	1320 x 560 mm/52" x 22"	350 mm/14"	315 kW/400 HP
NP15	1540 x 600 mm/60,6" x 24"	400 mm/16"	355 kW/450 HP
NP20	2040 x 700 mm/80,3" x 24,6"	400 mm/16"	630 kW/800 HP
NP110	1020 x 820 mm/40" x 32,3"	600 mm/24"	200 kW/250 HP
NP1213	1320 x 880 mm/52" x 34,6"	600 mm/24"	250 kW/350 HP
NP1315	1540 x 930 mm/60,6" x 36,6"	600 mm/24"	315 kW/400 HP
NP1520	2040 x 995 mm/80,3" x 39,2"	700 mm/28"	500 kW/700 HP
NP1313	1320 x 1200 mm/52" x 47,2"	900 mm/36"	250 kW/350 HP
NP1415	1540 x 1320 mm/60,6" x 52"	1000 mm/40"	315 kW/400 HP
NP1620	2040 x 1630 mm/80,3" x 64,3"	1300 mm/52"	500 kW/700 HP
NP2023	2310 x 1920 mm/91" x 75,6"	1500 mm/59"	1000 kW/1300 HP

Crusher sizes

There are many different crusher sizes. The first two figures in the NP Series™ model name indicate the diameter of the rotor. The last two figures indicate the feed opening width. For example, NP1415 has a rotor diameter of 1.4 m (55 in.) and a feed opening width of 1.5 m (60 in.).

NP impact crusher components

The main components of the NP Series™ impact crusher are the rotor, rotor shaft, frames, blow bars and breaker plates. Small mobile machines (NP110™ and NP1213™) have only one breaker plate.

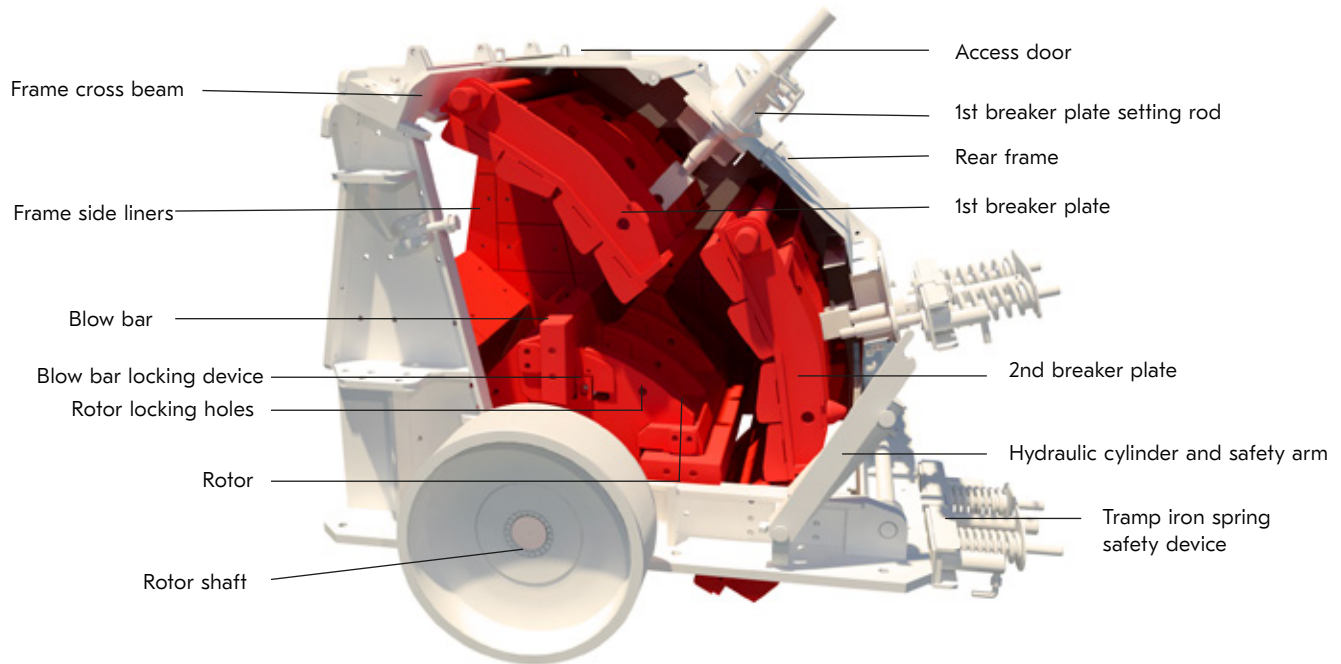

Setting

The space between the breaker plates and the blow bars only permits sized material to exit the crusher. Materials that are larger in dimension remain in the crushing cavity until the correct size is obtained. Then they are discharged. Normally, the crushing cavity is limited by two adjustable breaker plates, which control the crushed product size and capacity.

The closer the breaker plates are to the blow bars, the smaller the product size and the lower the capacity through the crusher. The smaller the setting, the faster the wear.

The further the breaker plates are from the blow bars, the higher the throughput of the crusher and the larger the product size.

The setting is the distance between the tip of the blow bar and the breaker plate when the blow bar is facing the bottom breaker plate liner. The measurement of the setting is obtained through the side access doors with the frame closed.

The minimum operation setting depends on the size, the nature of the feed material and the capacity through the machine.

The setting of the second breaker plate defines the size of the product discharged from the crusher. Knowing the setting of the second breaker plate S_2 and the feed material size (the largest dimension), the setting for the first breaker plate S_1 can be calculated using the following formula:

$$S_1 = (S_2 + \text{feed material size})/4 + 20 \text{ mm}$$

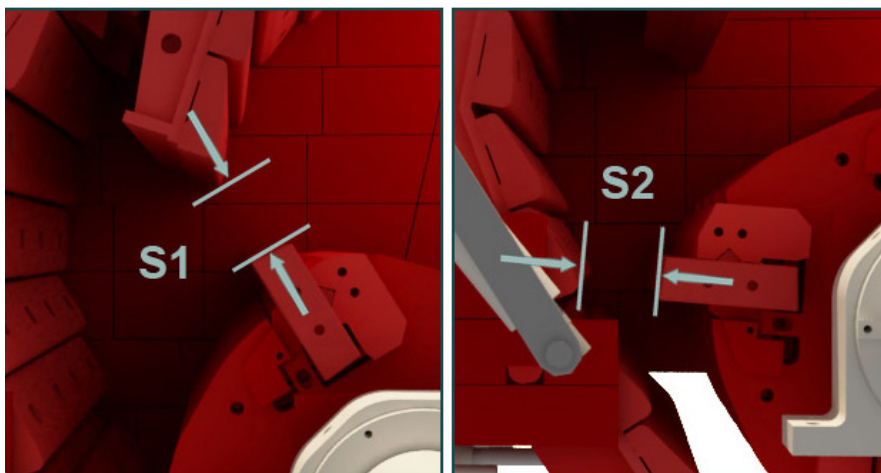



How to operate an NP Series™ impact crusher

The basic principle of operating an NP Series™ impact crusher is quite simple, but there are many factors that affect the throughput optimization. Some of these factors include feeding speed, feed material, water content, wear parts selection, and settings.

The table below offers an indication of how adjustments to your NP Series™ impact crusher affect power consumption, product gradation and product shape.



Effect

	Specific power consumption	Product gradation fineness	Product shape
Adjustment	↑	↑	↗
Decrease the setting	↑	↑	↗
Decrease the feeding	↓	↗	↗
Increase the speed	↑	↑	↗
Soften the feed material	→	↑	↗

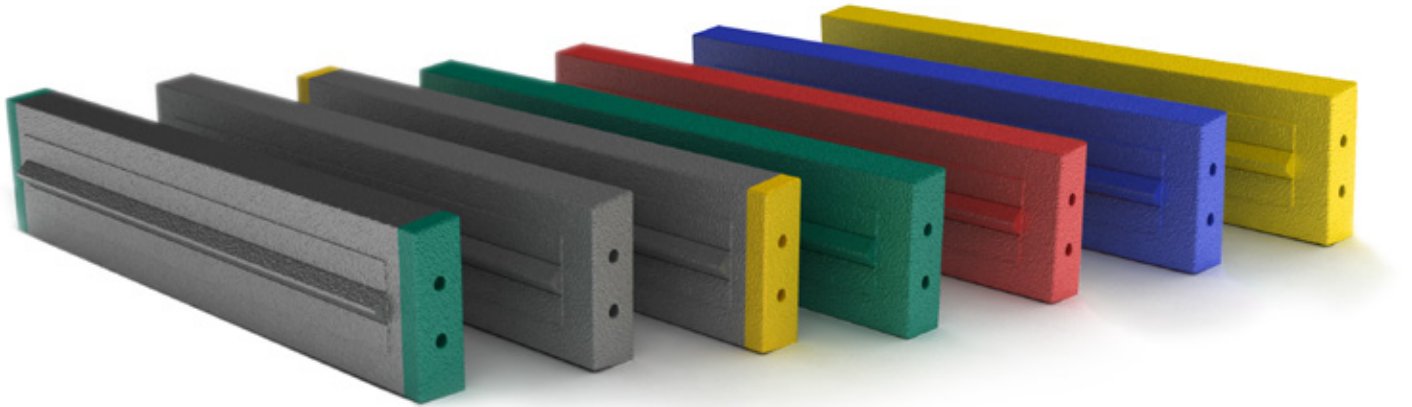

Wear parts selection

The selection of the liner type and material for impact crushers is fundamental to ensuring its desired performance. The liner should be chosen based on the material type, abrasion, foreign elements, and the size of the feed and the required end product, and according to the performance provided by the different metallic alternatives.

Indicative chart of the proportion of wear per element

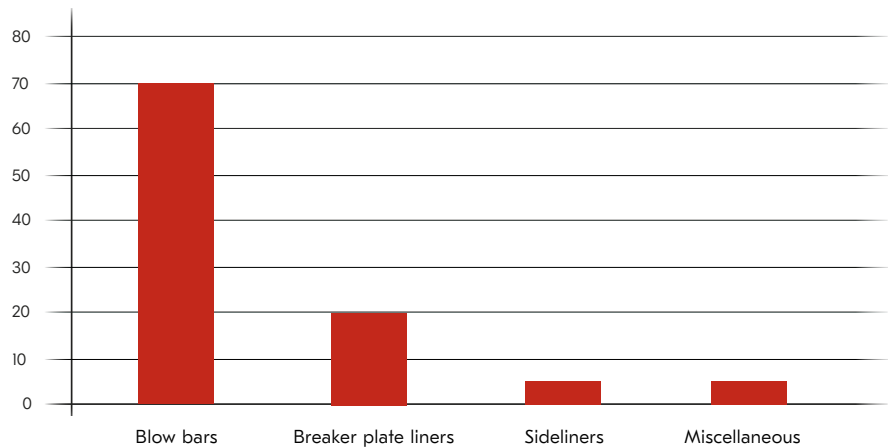

The different metallic alternatives include manganese steel, martensitic steel and white chromium iron. Metal matrix composite products have also been added to the selection and their significance on performance is remarkable.

Continuous impact resistance is vital for finer crushing applications, and shock resistance is needed in primary applications and in recycling crushing when metal scrap is entering the crushing chamber. The wear parts have been designed using sophisticated simulation methods. It is

important to choose the material that offers the best performance under normal operating circumstances.

The NP Impact crusher primarily has three different groups of wear parts: blow bars, breaker plate liners and side wear plates. Feed liners and discharge lips for conveyors in mobile applications are also considered as wear parts.

The blow bar is the component of an impact crusher that is most strongly subjected to mechanical stress. It accounts for 60-70% of the wear costs.

The proportion of wear per element corresponds more or less to its contribution to the crushing action. Therefore, the blow bars have the most significant wear because the most reduction work takes place when the blow bars strike the particles. See the attached table for indicative wear life.



Metso Outotec liners

Liners are wear parts that effectively protect the crusher. Metso Outotec offers breaker plate liners and side liners of different materials.

Breaker plate liners

The type of attaching system depends on the type of liner material.

- With manganese liners, the attaching system contains a bolt at the wear side of the liner.
- With a chromium iron liner, a hexagonal screw is attached directly from the opposite side to the liner.
- Compared with standard alloys, composite materials significantly increase the life span of the parts and the tonnage crushed by each set of parts – especially in more abrasive conditions.

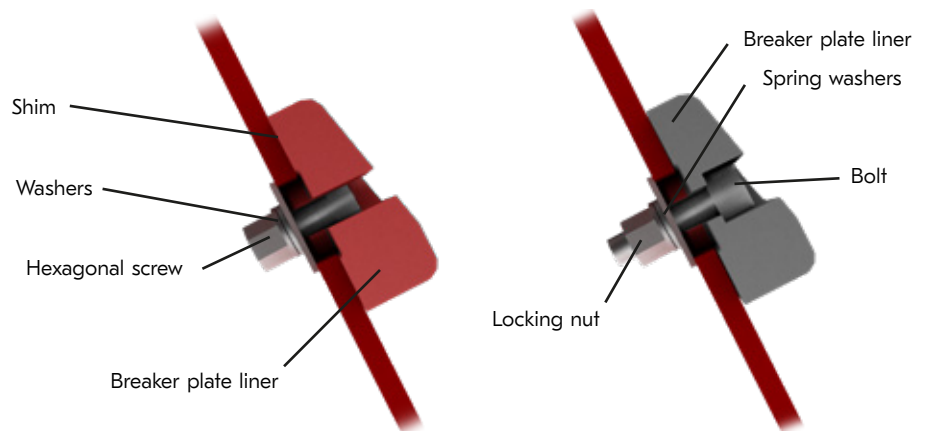

Side liners

Side liners protect the frame and are available in two types of hardness (400 and 520 HB). There are also two thicknesses available (20 and 30 mm).

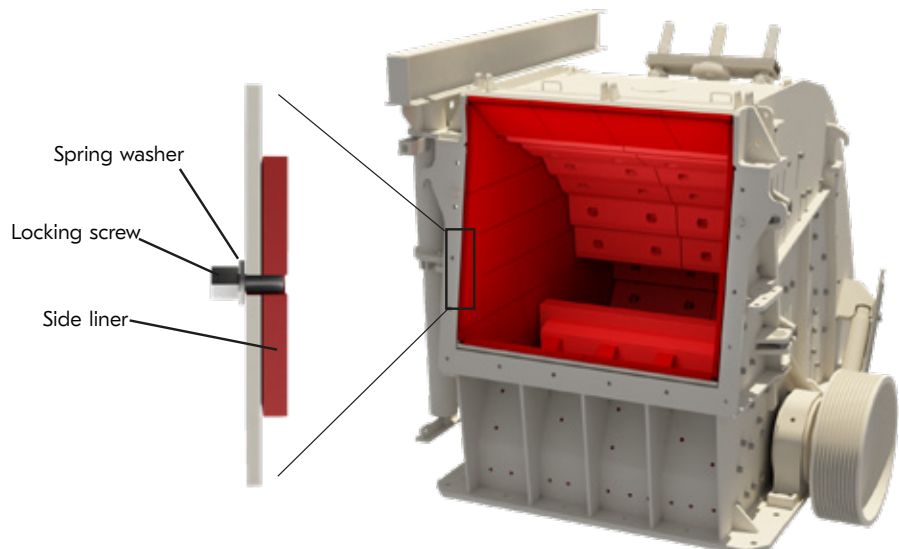

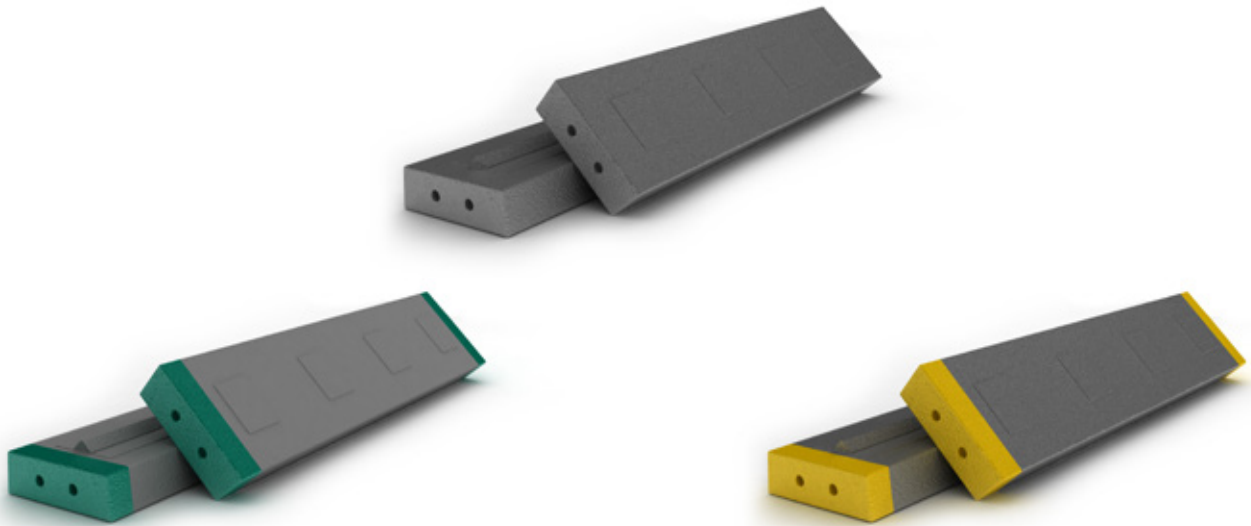

Metso Outotec blow bars

Speed and wear affect the blow bars and determinates the design.

In general, the blow bars are subjected to two types of stress: rim impact and central impact. Favorable energy conditions for crushing are achieved with central impact if the particle can penetrate with its center of gravity into the orbit of the blow bar. The proportion of rim impacts is higher than for central impacts. The consequence is a strong rounding of the blow bar edge. Extending the blow bar height and adjusting the rotor speed to the conditions can result in an improvement in the central impact.

Rotor speed plays an important role in the crushing effect and on the wear of the blow bars. In fact, increasing the speed increases the kinetic energy distributed to the material, so creating more blow bar surfaces leads to a longer wear life.

The red block presents six faces. Considering that increasing the rotor speed would increase the kinetic energy to break the red block into the two green blocks, it's easy to see that compared with the red blocks we have created two new faces, each equivalent to one face of the red block. If the speed were even higher — so that the red block breaks into the three yellow blocks, you can see that we would have created four new faces, each equivalent to one face of the red block. Each new face is a new opportunity to increase the blow bar wear. Thus we can distinctively associate the speed with the wear. The relation between speed and wear can be summarized by the following formula:

$$L = K * W^2$$

L represents the blow bar wear, K represents the specific wear factor and W represents the rotor speed.

It appears that the wear does not increase proportionally with the speed, it is a function of the square of the speed. Thus we have to consider the life length (in hours) of the blow bar, depending on the abrasiveness of the material. Some other parameters, like adjustment setting, can influence the wear. It appears that a smaller crushing chamber (small setting) contributes to less wear on the blow bars than a larger one. The reason is assumed to be in the shorter trajectories of the particles in the process zone, which contributes to an improvement of the discharge behavior of rock particles from the impact chamber.

A 15° inclination of the blow bar in the direction of the rotor's rotation presents lesser wear than a 15° inclination in the opposite direction of the rotor's rotation. This is due to the sliding effect of the material on the blow bars. But this can be negligent compared with the speed effect and material effect.

When the blow bars are new and present a plane surface and a sharp edge, the impact is more violent, and the energy explodes the stones in many pieces. When the blow bars are worn and rounded, the stones are only scuffed by the blow bar edges. They are less fragmented and the energy of the impact is lower.



New blow bar



Worn out blow bar

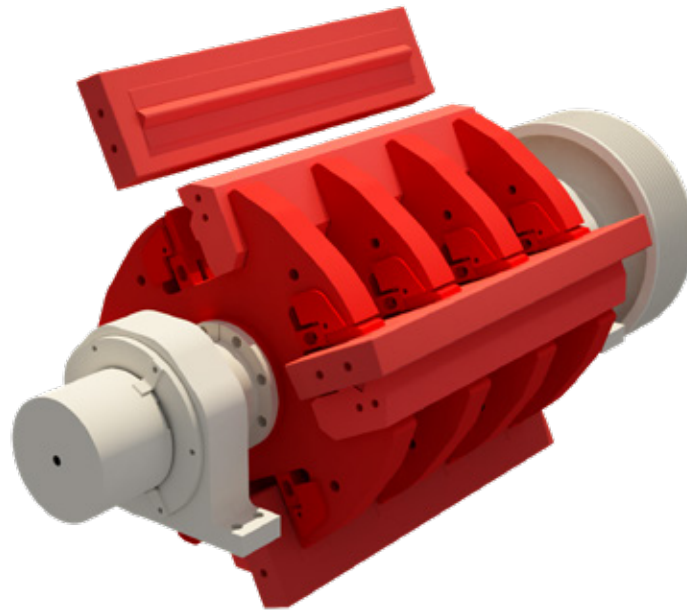

Blow bar material selection

The choice of material used in Metso Outotec's blow bars depends on the application. The strength of each material is described below.



Manganese

This is mainly Metso Outotec XT510™ manganese. This alloy is used in primary crushers or in crushers that have tramp iron in the feed. Manganese steels are used whenever very high shock resistance or some elongation is needed. The blow bar life is not easily predictable and depends on many

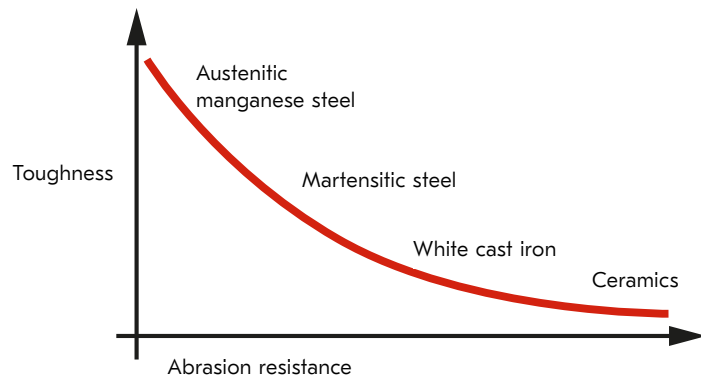

factors.

Martensitic (alloy) steel

Martensitic steel is used whenever hardness and impact resistance are both needed, i.e. in all the applications where usage of white (chromium) irons can lead to breakage. Generally, martensitic steel has a longer lifetime than manganese steels in more abrasive applications when the feed size is below 900 mm. It is used in primary and recycling applications.



White cast iron (chromium)

White irons are used when the shock level is rather low and the castings rather thick. The feed to the crusher must be well prepared in terms of top size and must be free of tramp iron. Because of the brittle nature of this alloy, tramp iron will cause catastrophic failure of the blow bars. This material is used in secondary, tertiary and asphalt recycling applications where there is no tramp iron.

Composite solution

Metal Matrix Composite (MMC) is a metallic matrix (steel or cast iron) and ceramic alloy. The ceramic part consists of particles spread across the wear surface. These composites combine the effects of the very hard surface of ceramic with the useful mechanical properties of cast iron or steel. This combination makes the whole structure sufficiently tough to resist to breakage during service.

Compared with standard alloys, this solution considerably increases the lifetime of the parts and the tonnage crushed by each set of parts, especially in more abrasive conditions. Metso Outotec's MMC offering includes Xwin® martensitic, Xwin® white iron (chromium), Recyx® and neoX®.

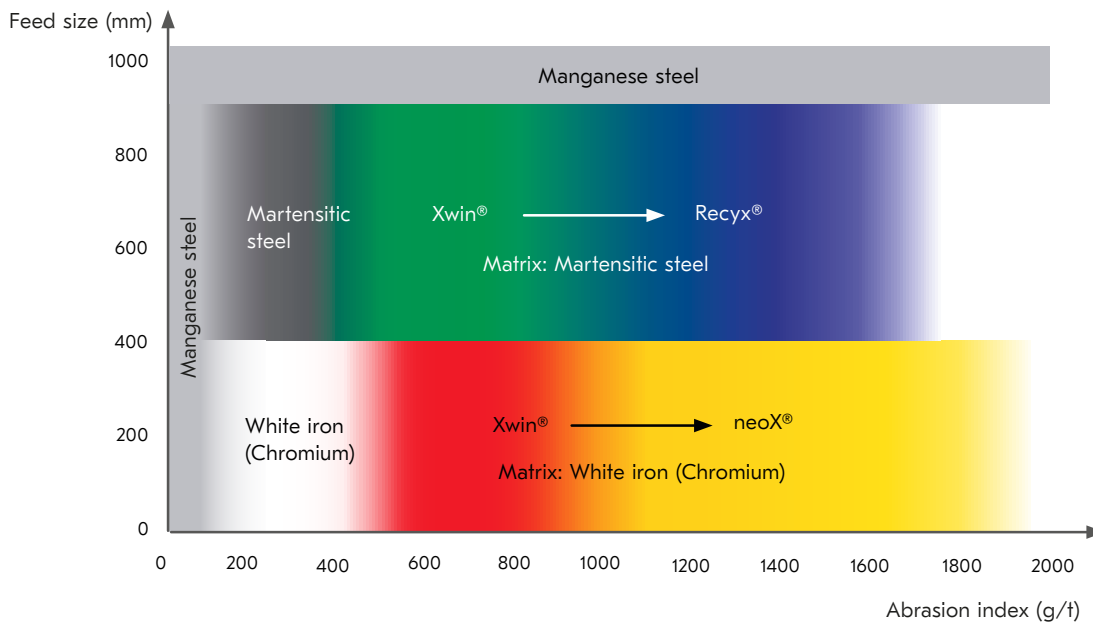

Xwin® martensitic steel/ceramic

MMC blow bar consisting of hard ceramic particles on the wear surface in a martensitic steel matrix. This composite combines the effects of the very hard surface of ceramic with the useful mechanical properties of steel. These (martensitic/ceramic) blow bars can have two to four times the life of standard mono-alloy blow bars.

- Recycling industries (primary)
- Concrete
- Asphalt
- Quarries (primary)
- NOT suitable for slag recycling (too abrasive) or limestone (lifetime too long, risk of metal stress)

Recyx® martensitic steel/ceramic



MMC blow bar consisting of hard ceramic particles on the wear surface in a new martensitic steel matrix. The ceramic inlay is deeper and wider than the standard Xwin

and will provide a longer lifetime. These are high performance blow bars for recycling applications.

- Recycling industries (primary)
- Concrete
- Asphalt
- Quarries (primary)
- NOT suitable for slag recycling (too hard), or limestone (lifetime too long, risk of metal stress)



neoX® (Xwin® III) high chromium iron/ceramic

MMC blow bar consisting of hard ceramic particles on the wear surface in a chromium iron matrix. The quality of the ceramic inlay has a more durable wear resistance than the standard Xwin®. Designed especially for gravel pit or quarry applications.

- Secondary application in very abrasive working conditions (quarries and gravel pits, steel slag etc.)
- Asphalt (when no risk of unbreakable parts)
- Main target is in applications where Xwin® white iron gains no lifetime improvement against monoalloy solution
- NOT suitable for primary crushers or low-to middle-abrasive conditions



Xwin® white iron (chromium)/ceramic

MMC blow bar consisting of hard ceramic particles on the wear surface in a chromium iron matrix. This composite combines the effects of the very hard surface of ceramic with the useful mechanical properties of chromium iron. These (chromium/ceramic) blow bars can have two to four times the life of standard mono-alloy blow bars.

- Secondary application in quarries and gravel pits.
- Asphalt (when no risk of unbreakable parts)
- NOT suitable for primary crushers or extreme abrasive/hard materials. Carbide based matrix accepts near to no shocks.

Note: Xwin®, Recyx® and neoX® are produced by Magotteaux for Metso Outotec. Xwin®, Recyx® and neoX® are registered trademarks of Magotteaux.

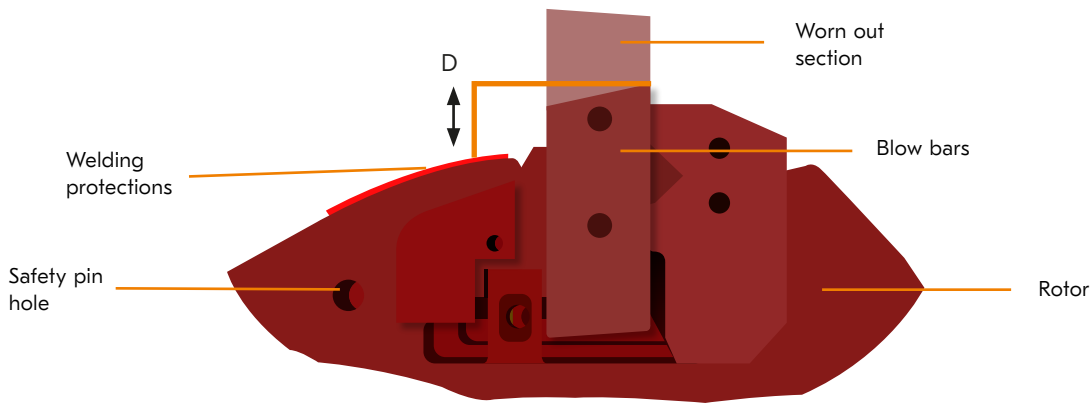

	NP1110™	NP1213™	NP1315™	NP1520™	NP1313™	NP1415™	NP1620™	NP2023™
Dimension D in the illustration	55 mm 2.2 in	60 mm 2.4 in	70 mm 2.8 in	70 mm 2.8 in	60 mm 2.4 in	70 mm 2.8 in	80 mm 3.2 in	50 mm 2.0 in

When to change wear parts

When blow bars should be changed

In order to avoid damage to the rotor, blow bars should be replaced before they are worn through. The wear limit "D" is shown in the illustration above. When changing and turning around blow bars, follow the instructions in the Nordberg® NP Series™ Impact crusher instruction manual.

Blow bar replacement

Blow bars are reversible. When one face is used, the blow bar can be turned around to use the other face. This procedure can only be done once.

Blow bars may need to be changed or turned around earlier if the wear profile is distorted. Unevenly worn blow bars may decrease production. Incorrect feeding or feed gradation can lead to distorted wear profiles.

It is recommended to change all four blow bars simultaneously. However, the slotted configuration can be used in some applications. The slotted configuration (two worn blow bars and two new blow bars diametrically opposed) will produce a discharge curve with a smaller amount of fines.

Breaker plate replacement

In order to maximize the lifetime of the breaker plates, the breaker plates of Metso Outotec's machines are protected against wear by having several same-sized breaker plate liners. Because the wear profile is not identical throughout the crushing chamber, the breaker plate liner positions can be rotated. Wear is higher on the bottom of the chamber.

If a few liners are worn, you are not obliged to change whole set of liners. You can either change the placement of the liners or just replace the worn ones.



Note: See the instruction manual for more information about when and how to change wear parts.

How to change wear parts

Always follow the safety instructions during all maintenance and lifting work.

Blow bar replacement

The blow bars are reversible. When one side is worn, the blow bar is turned so that the other side can be used.

1. Open the frame and make sure the safety arms are engaged.
2. Fit the safety pin supplied with the toolkit into the frame's hole and the rotor's hole. This safety pin locks the blow bar in the raised position.
3. Use the lifting yoke. A bracket and an electric hoist are supplied as optional extras on the machine; if you do not have this equipment, use hoisting gear with a capacity matching the load to be lifted.
4. Clean underneath the blow bars and chocks if necessary.
5. Lower the lifting beam into position on the blow bar and screw in the four screws of the lifting beam.
6. Insert the pins through the upper chocks to hold them in place. Clean the threads of the lock screws in the lower chocks. Loosen the screws and remove the lower chocks by hitting them with a hammer if necessary to release them.
7. To prevent the blow bar from suddenly dropping, make sure it is firmly held in place by tightening the lifting cable.
8. Ease the blow bar forward and lift it vertically.
9. Thoroughly clean the rotor's bearing surfaces, the blow bar and the chocks.
10. When the blow bars are replaced, it is important that rotor balance is maintained. Mount the blow bars that are of equal weight in a position that is 180 degrees from each other. The weights are usually indicated on the blow bars. If in doubt about the weights of the two diametrically opposed blow bars, weigh them to make sure they are of more or less the same weight. Position the large upper chocks. Place the new blow bar into its housing. Keep the upper chocks in position with pins. Position the lower chocks and their lock screw.
11. Tighten the screws alternately, starting with those at the ends; the blow bar should be firmly locked onto its bearing surfaces.
12. Perform the same actions for the three other blow bars, starting with the one that is diametrically opposed; since the new blow bar is heavier, it naturally goes at the bottom.
13. Remove the pin, rotate the rotor by hand and make sure the blow bars are correctly in their housing.
14. Close the frame again and set the breaker plates.
15. Run normally for roughly one hour so that the parts settle into place.

Breaker plate removal

1. Open the structure and ensure that the safety arm is engaged.
2. Install the safety spindle.
3. Open the inspection hatches.
4. Clean around the liner.
5. Remove a screw from the worn liner.
6. Fix the tool to the liner using the through-bolt, the nut and washer.
7. Tighten the set screws. These are used to compensate for the slope of the liner.
8. Check that the liner is correctly fixed to the tool. This must fit tightly to the liner.
9. Bring the suitable lifting equipment into position and hook the tool by its lifting point onto the hook or shackle. Tighten slightly.
10. Loosen the other liner screw. During this operation hold the tool by the handle. Be prepared for the tool kickback and take care to not stand beneath the load.
11. Place the liner on the ground and use a new liner, if necessary, as a replacement.

Breaker plate installation

1. Fix the tool to the liner using the through-bolt, the nut and washer.
2. Tighten the set screws. These are used to compensate for the slope of the liner.
3. Use the lifting point to lift the assembly. Use the appropriate lifting equipment.
4. Bring the breaker plate liner into position by using the handle.
5. Put the liner in place on the breaker plate.
6. Tighten the liner screw that was left loose onto the breaker plate. The liner is now held on the breaker plate by one bolt.
7. Unscrew the tool retaining screw.
8. Remove the tool and tighten the second liner screw onto the breaker plate.
9. Tighten the self-locking nuts again until the lock washers are fully compressed. Tighten periodically if necessary.

Frame liner replacement

The liners are tapped and secured firmly against the frame with screws and lock washers. Tighten until the lock washer is compressed.



Maintenance tools

As part of its ongoing safety and environmental procedures, Metso Outotec has developed tools to improve the safety and ease of wear parts maintenance in NP Series™ impact crushers.

Breaker plate cassette

Metso Outotec has innovated a new breaker plate cassette. This patented solution consists of a removable assembly that allows for an easy and safe breaker plate liner replacement outside the crusher.

Maintenance bridge

The new maintenance bridge gives you safe access to the rotor while changing blow bars. The maintenance bridge also gives you easy access to the side liners, including the ones located at the highest point.

Lifting tool

Metso Outotec's lifting tool is used for handling breaker plate liners. It is suitable for all NP Series™ impact crushers and is easy to use. It is adaptable to new crushers or even those that have been in operation for many years. The purpose is to improve working conditions by making maintenance easier and safer.

Breaker plate liner and blow bar lifting tool

Specially designed, fit-for-purpose tools make wear part change-outs faster and more efficient. By using OEM parts, risk of damaging equipment is avoided. As a result, maintenance times are shortened and crusher downtime is reduced.

To succeed in today's competitive environment, aggregate producers often seek to optimize their crusher maintenance. Using parts that last longer and make crusher maintenance easier and safer can make the big difference. Metso Outotec's specialty tools are developed with quality suppliers ensuring that high standards and tolerances are met.

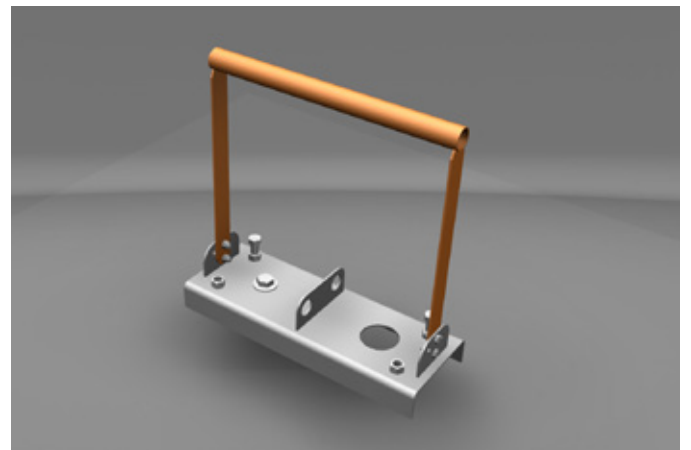

Breaker plate liner lifting tool

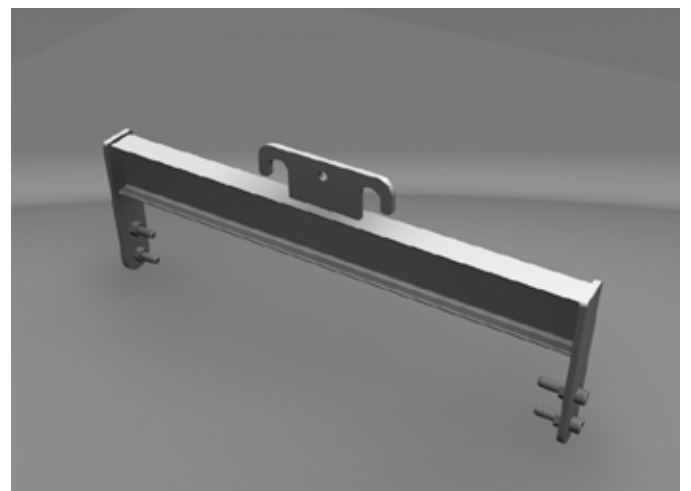

Blow bar lifting tool



Maintenance bridge



Breaker plate cassette



