

ZW310



WHEEL LOADER

Model Code: ZW310-5A
Engine power: 216 kW (290 HP)
Operating Weight: 22 410 - 22 860 kg
Bucket ISO Heaped: 3.4 - 4.5 m³

Amazing Performance with Enhanced Controllability

The new ZW310 wheel loader employs advanced technologies to achieve excellent productivity with enhanced controllability. Furthermore, the machine has a comfortable cab, easy maintenance features, and Hitachi's comprehensive service package, including ConSite, enabling operators to work efficiently in tough environments.

CONTENTS

Powerful and Efficient Operation

Page 4 - 5

Production and efficiency

Enhanced Controllability

Page 6 - 7

Controllability

Operator-Friendly Features to Improve Operator Comfort

Page 8 - 9

Operator comfort

Simplified Maintenance and Durability with Proven Support System

Page 10 - 11

Maintainability and durability

The New **ZW310** Wheel Loader



ZW Empower your Vision.

Note: The photos in the brochure may include optional equipment, such as pre-cleaner.

Powerful and Efficient Operation

Operators can choose between 2 modes according to job site requirements.



PICK UP Extra Power with Power Mode

Standard mode is preselected and sufficient for ordinary work. On the other hand, the power mode gives extra power when needed. It is particularly useful on sites where strong traction or acceleration is required.

	Slope climbing	Handling	Acceleration
Power Mode			
Standard Mode			

NEW 2 Ways to Activate Power Mode



Power mode can be activated by 2 ways and operators can choose either switch depending on the site required.

A Quick Power Switch (QPS)

Use the QPS on the lever when extra power is needed temporarily, such as climbing a steep slope. When switching forward/reverse or when the travel load reduces, the power mode selected via the QPS automatically reverts to the standard mode. By using the QPS, the power mode is activated only when needed and this helps to reduce fuel consumption.

B Power Mode Switch

Use the power mode switch when extra power is needed constantly, such as moving heavy materials like rocks, and getting the job done quickly. When the power mode is activated via the power mode switch, the mode will remain on until the engine is turned off.

NEW Active Engine Control System for Economical Operation and Easy Control



The "Active Engine Control System" plays a key role achieving economical operation. Strategically positioned sensors detect movements throughout the machine and adjust engine speed accordingly to eliminate energy losses to maximize fuel conservation. This delivers smooth, fuel-efficient operation.

Parallel Tandem for Smooth Operation

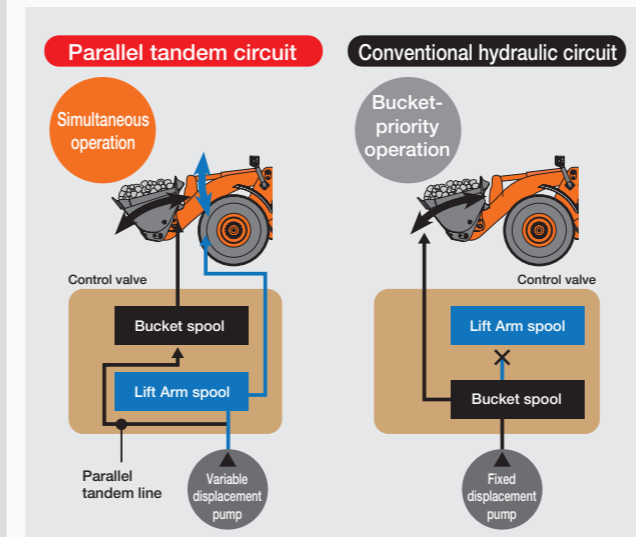

The parallel tandem circuit carries out simultaneous operations of the bucket and the lift arm. Front work such as excavation and loading can be done smoothly and boosts the efficiency.

NEW ECO Mark Indicator for Fuel-Efficient Operation



Monitor indication items:

Speed meter, clock, hour meter, odometer, oil/filter hour meter

The ECO mark indicator turns on when fuel-efficient operation is activated. This function encourages operators to utilize fuel-efficient operation.

Enhanced Controllability

Hitachi analyzed various wheel loader operations including digging, approach to a dump truck, operation after dumping and travel. This led to the development of features to improve wheel loader controllability.



PICK UP New Transmission

The new transmission comes standard with the Auto mode* that can automatically select an optimum gear according to the load, thereby reducing fuel consumption.

* AUTO1 (1st-4th gear) and AUTO2 (2nd-4th gear) are selectable using travel mode selector.

AUTO1	Automatic gear shift: gears 1-4			
AUTO2	1st	Automatic gear shift: gears 2-4		
Manual	1st	2nd	3rd	4th



Travel mode selector

NEW Levers for Easy Operation



Two levers



Fingertip control



Grip control

In order to offer more efficient and comfortable operation, a new type of lever is employed to suit both fingertip control and grip control.

* A variety of lever patterns are available depending on job needs and operator's preference.

NEW Speed-Responding Clutch Cut-Off System



Clutch cut-off timing is adjusted by sensing travel speed and pedal depression for smooth, efficient truck loading. The Flat mode, Slope mode and OFF are selectable by switch control according to job requirements.



Clutch cut position switch

NEW Shift Change Delay Mode (Optional)

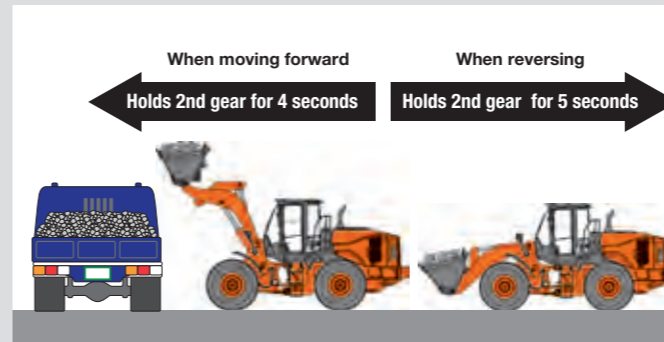

Shift change delay mode is provided to avoid an excessive rise in travel speed during approaching to a dump truck/hopper. When moving forward, the second gear is kept for 4 seconds to prevent over-speed. When reversing, the second gear is kept for five seconds. These delays to third gear help to keep fuel consumption down ensuring smooth loading.

Lift Arm Restriction Valve

This restriction valve suppresses the shaking of the machine when the lift arm stops to improve operator comfort and avoid load spills.

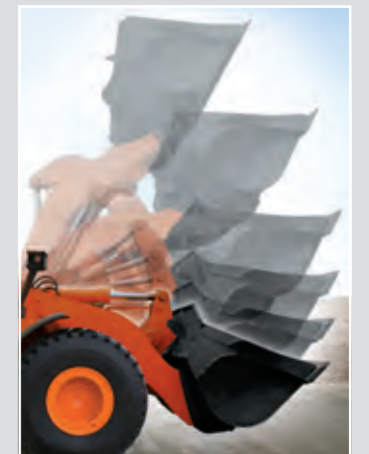

Lift Arm Auto Leveler (Optional)

The lift arm can be automatically stopped at a preset level for efficient truck-loading, and lowering the bucket after dumping. The operator can concentrate on traveling without worrying about the lift arm.

Operator-Friendly Features to Improve Operator Comfort

The cab is both comfortable and functional with a series of features aimed at reducing operator fatigue.

PICK UP Bi-Level Auto Air Conditioner

This auto air conditioner has bi-level control function: warming at foot space and cooling at overhead. The pressurized cab shuts out dust, keeping the cab interior clean. In dusty environments, optional external double-filters are available for the air conditioner.



Panoramic Cab



The spacious panoramic cab offers near all-round visibility through pillar-less bonded windows, enhancing safety. The seat and steering wheel can be adjusted to suit the operator, keeping the operator in an optimum position. In-cab noise is suppressed further. Even when the going gets tough, the operator can feel comfortable with less fatigue.

Tilttable Steering Wheel

The steering wheel is tilttable to fit the wheel to the operator for comfortable operation.



Tilttable steering wheel

Comfort-Designed Suspension Seat

The mechanical suspension seat absorbs shocks and vibration from the machine in order to reduce operator's physical stresses.

* The air suspension seat is available as an option.



Suspension seat

AM/FM Radio with 2 Speakers

The AM/FM radio has an auto-tuning feature and the 2 speakers stereo system provides excellent sound quality.



AM/FM radio with 2 speakers

* An AUX port (stereo mini jack) is an option for connection with a mobile music player for entertainment during breaks.

NEW Rearview Monitor (Optional)

The rearview monitor allows the operator to see the rear of the machine, including a view behind the counterweight. This rearview monitor enhances safe operation.

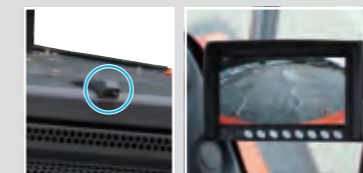

Rearview camera Rearview monitor

An Array of Convenient Accessories



Drink holder



Large storage space



Storage for small items



Hot and cool box

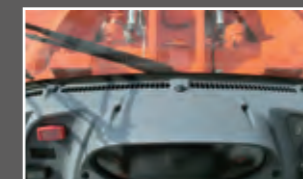

Front defroster



Rear air outlet

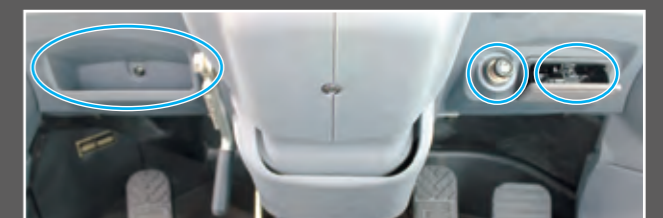

Glove compartment, cigarette lighter and ashtray

Simplified Maintenance and Durability with Proven Support System

Hitachi Support Chain offers a comprehensive suite of support services for customers.



PICK UP Simplified Maintenance

The engine cover swings up to provide a wide service space. Inspection/maintenance points are concentrated for easy inspection and servicing from the ground.

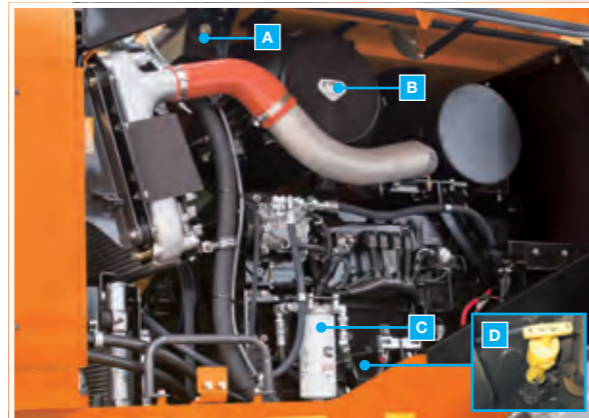

- A Coolant reservoir sight gauge
- B Air cleaner element
- C Fuel filter
- D Engine oil gauge

Robust Frame

The main frame and its joints are thoroughly strengthened. The box-section structure is adopted around center pins, where concentrated forces are applied, for reinforcement. Frame plate thicknesses are optimally determined by 3D stress analysis.



Robust frame

Wide Fin Pitch Radiator (Optional)

Wide fin pitch radiator is available for use in dusty environments, where there are large amounts of airborne debris, to avoid dust clogging and overheating as a result. Cleaning the radiator by air blowing is easy and simple.

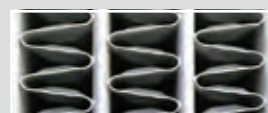

Standard fin pitch radiator

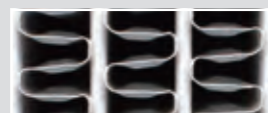

Wide fin pitch radiator

NEW Automatic Reversible Cooling Fan (Optional) to Reduce Dust Deposits



Cooling fan

The automatic reversible cooling fan is available to keep the radiator clean at all times. The cooling fan is automatically self-reversed every 30 minutes to blow dust off the radiator.

Parts and Service

Parts

Hitachi Global Online Network, a parts supply system, is linked with CPD (Central Parts Depot), overseas depots and dealers abroad to deliver on-line parts information, including in-stock parts, order receptions, shipments and delivery period of over one million parts and components.

Genuine Hitachi Parts

Genuine Hitachi parts, meeting Hitachi stringent quality standards, are guaranteed according to Hitachi warranty standards. The use of genuine Hitachi parts, including engine, fuel, hydraulic oil and filters, may slash running costs, and extend machine life.

Service

ConSite

ConSite is a full-package service menu which is designed for Hitachi's machines used around the world. It closely monitors the entire operation status of your machine to improve its overall performance and increase machine's availability and efficiency.

Technical Training

On-site servicing matters despite locations to keep the machine at peak performance and reduce downtime. Technical Training Center (TTC), located in Japan, educates and trains service technicians and service support personnel coming from Hitachi dealers and factories on the globe according to the international training programs.



SPECIFICATIONS

ENGINE

Model	CUMMINS QSM11
Type	4-cycle, water-cooled, direct injection
Aspiration	Turbocharger and intercooled
No. of cylinders	6
Maximum power	
SAE J1995/ISO14396, gross.....	239 kW (320 HP) at 1 800 rpm
SAE J1349/ISO 9249, net	236 kW (316 HP) at 1 800 rpm
Rated power	
SAE J1995, gross.....	216 kW (290 HP) at 2 100 rpm
Maximum torque	1 478 Nm at 1 000 - 1 400 min ⁻¹ (rpm)
Bore and stroke	125 mm X 147 mm
Piston displacement	10.82 L
Batteries	DC 12 V X 2
Air cleaner	Double element dry type with restriction indicator

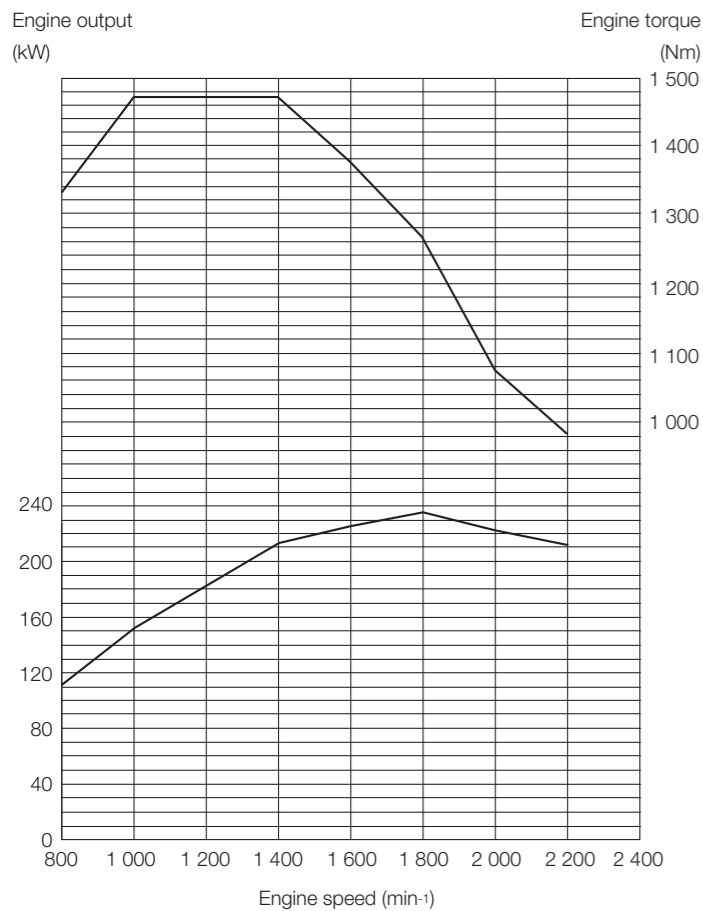

POWER TRAIN

Transmission	Torque converter, countershaft type powershift with computer-controlled automatic shift and manual shift features included.
Torque converter	Three element, single stage, single phase
Main clutch	Wet hydraulic, multi-disc type
Cooling method	Forced circulation type
Travel speed* Forward / Reverse	
1st	6.8 / 6.8 km/h
2nd	11.5 / 11.5 km/h
3rd	21.6 / 21.6 km/h
4th	34.7 / 34.7 km/h
* With 26.5-25-16PR (L3) tires.	
Data at power mode are the same as data at standard mode.	

AXLE AND FINAL DRIVE

Drive system	Four-wheel drive system
Front & rear axle	Semi-floating
Front	Fixed to the front frame
Rear	Trunnion support
Reduction and differential gear	Single stage reduction with torque proportioning differential (std) / limited slip differential (optional)
Oscillation angle	Total 20° (+10°, -10°)
Final drives	Heavy-duty planetary, mounted inboard

TIRES

Tire size	26.5-25-16PR (L3)
Optional	Refer to standard & optional equipment list

BRAKES

Service brakes	Inboard mounted fully hydraulic 4 wheel wet disc brake. Front & rear independent brake circuit
Parking brakes	Spring applied, hydraulically released, located in transmission

STEERING SYSTEM

Type	Articulated frame steering
Steering angle	Each direction 37° ; total 74°
Cylinders	Double-acting piston type
No. x Bore x Stroke	2 x 70 mm x 542 mm

HYDRAULIC SYSTEM

Lift arm and bucket are controlled by independent control lever.	
Lift arm controls	Four position valve ; raise, hold, lower, float
Bucket controls with automatic bucket return-to-dig control	Three position val+e ; roll back, hold, dump
Main pump (Serve as steering pump)	
.....	Variable displacement axial piston pump
Maximum flow	323 L/min at 2 000 min ⁻¹ (rpm)
Maximum pressure ..	29.4 MPa
Fan pump	
.....	Fixed displacement gear pump
Maximum flow	84.9 L/min at 2 000 min ⁻¹ (rpm)
Maximum pressure ..	17.4 MPa
Hydraulic cylinders	
Type	Double acting type
No. x Bore x Stroke ...	Arm : 2 x 145 mm x 930 mm Bucket : 1 x 185 mm x 510 mm
Filters	Full-flow 15 micron return filter in reservoir
Hydraulic cycle times*	
Lift arm raise	6.2 s
Lift arm lower	3.2 s
Bucket dump	1.2 s
Total	10.6 s

* Data at power mode are the same as data at standard mode.

SERVICE REFILL CAPACITIES

Fuel tank	370 L
Engine coolant	40 L
Engine oil	34 L
Torque converter & transmission	52 L
Front axle differential & wheel hubs	48 L
Rear axle differential & wheel hubs	48 L
Hydraulic oil tank	123 L

DIMENSIONS & SPECIFICATIONS

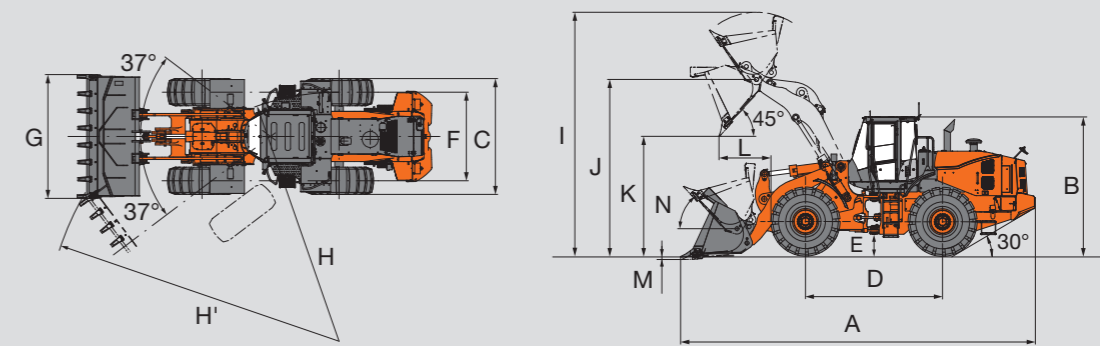

Bucket type		Unit	Standard arm				High lift arm	
			General purpose		Rock bucket	General purpose		
			Bolt-on cutting edge	Bolt-on teeth	Bolt-on teeth	Bolt-on cutting edge		
Bucket capacity	ISO heaped	m ³	4.0	4.5	3.8	4.3	3.4	4.0
	ISO struck	m ³	3.5	4.0	3.3	3.8	2.9	3.5
A Overall length		mm	8 790	8 910	8 930	9 050	8 900	9 240
B Overall height		mm	3 470					
C Width over tires		mm	2 930					
D Wheel base		mm	3 450					
E Ground clearance		mm	505					
F Tread		mm	2 230					
G Bucket width		mm	3 100	3 100	3 120	3 120	3 120	3 100
H Turning radius (Centerline of outside tire)		mm	6 270					
H' Loader clearance radius, bucket in carry position		mm	7 330	7 360	7 385	7 415	7 375	7 520
I Overall operating height		mm	6 100	6 215	6 100	6 215	5 775	6 555
J Height to bucket hinge pin, fully raised		mm	4 410					
K Dumping clearance 45 degree, full height		mm	3 095	3 010	2 975	2 890	3 000	3 550
L Reach, 45 degree dump, full height		mm	1 215	1 300	1 280	1 370	1 235	1 245
M Digging depth (Horizontal digging angle)		mm	95	95	125	125	125	95
N Max. roll back at carry position		deg	50					
Static tipping load *	Straight	kg	17 090	16 940	17 260	17 120	17 280	14 100
	Full 37 degree turn	kg	14 910	14 780	15 060	14 930	15 080	12 300
Breakout force		kN	184	169	198	181	202	184
		kgf	18 770	17 240	20 200	18 460	20 600	18 770
Operating weight*		kg	22 540	22 670	22 410	22 540	22 620	22 860

Note: All dimensions, weight and performance data based on ISO 6746-1:1987, ISO 7131:2009 and ISO 7546:1983

: Static tipping load and operating weight marked with include 26.5-25-16PR(L3) tires (No ballast) with lubricants, full fuel tank, 2 080kg counterweight, ROPS cab and operator. Machine stability and operating weight depend on counterweight, tire size and other attachments.

WEIGHT CHANGE

Option item	Operating weight (kg)	Tipping load (kg)		Overall width (mm) (outside tire)	Overall height (mm)	Overall length (mm)
		Straight	37 degree turn			
Tire	26.5-25-16PR (L3)	±0	±0	±0	±0	±0
	26.5-25-20PR (L3)	+100	+70	+60	±0	±0
	26.5-25-20PR (L4)	+580	+420	+370	±0	±0
	26.5-25-20PR (L5)	+940	+690	+600	±0	±0
	26.5R25 (L3)	+100	+70	+60	±0	±0
	26.5R25 (L4)	+500	+360	+320	+15	+30
26.5R25 (L5)	+840	+620	+540	+15	+30	-25
Belly guard (front frame)	+100	+30	+30	-	-	-
Belly guard (rear frame)	+95	+100	+90	-	-	-
2 540 kg Counterweight	+460	+1 070	+930	-	-	-

BUCKET SELECTION GUIDE

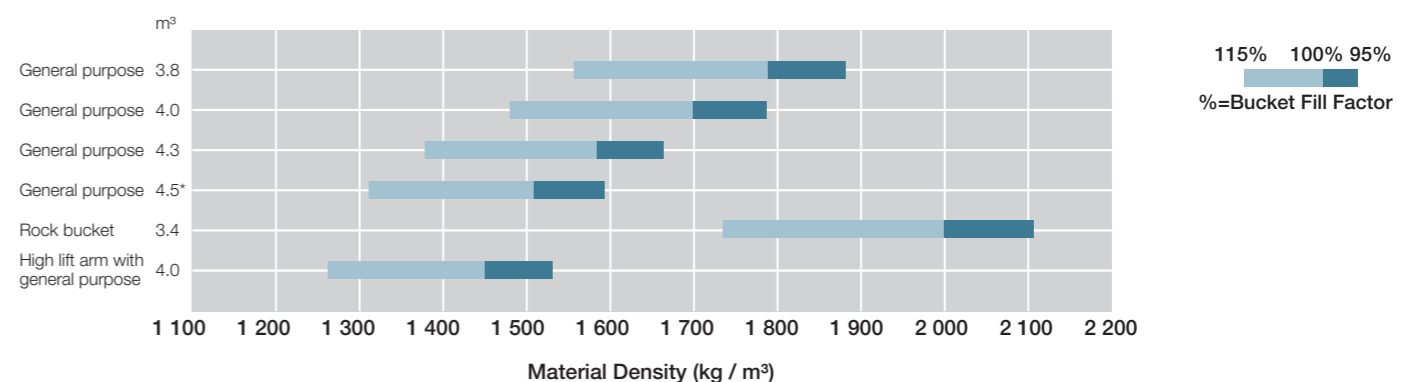

EQUIPMENT

● Standard equipment ○ Optional equipment

OPERATOR'S STATION

Adjustable steering column	●
Ashtray, cigar lighter	●
Audio	
AM/FM radio	●
AM/FM radio with AUX for digital audio player	○
Auto control air conditioner	
with single intake filter	●
with double intake filter	○
Cab	
ROPS (ISO3471), FOPS (ISO3449)	●
Non ROPS / FOPS cab	○
Coat hook	●
Front/Rear defroster	●
Glove compartment	●
Rear view camera & monitor	○
Rear view mirrors	
Inside (2)	●
Outside (2)	●
Retractable seat belt, 50 mm	●
Rubber floor mat	●
Seat	
Mechanical suspension seat: fabric, high back, adjustable for armrest angle, fore-aft position, reclining angle and weight-height.	●
Air suspension seat with headrest and heater: fabric, high back, adjustable for armrest angle, damper, fore-aft position, headrest height and angle, inclination of the seat, lumbar support, reclining angle, seat depth and weight-height.	○
Storage	
Cup holder	●
Digital audio player holder (with AUX for digital audio player)	○
Document holder	●
Hot & cool box	●
Seatback pocket	●
Sun visor	●
Textured steering wheel with spinner knob	●
Safety glass (tempered)	●
Windshield washer front and rear	●
Windshield wipers front and rear	●

ELECTRICAL SYSTEM

Backup alarm	●
Batteries	
Standard batteries (108 Ah-765 CCA)	●
Large capacity batteries (140 Ah -930 CCA)	○
Battery disconnect switch	○
12 V power outlet	○

COOLING SYSTEM

Fan	
Cooling fan with heat sensing	●
Automatic reversible cooling fan with heat sensing	○
Fan guard	●
Radiator	
Standard fin pitch radiator	●
Wide fin pitch radiator	○

LIGHTS

Brake & tail lights	●
Clearance lights	●
Headlights	●
Turn signals with hazard switch	●
Work lights	
Front lights on cab (2)	●
Rear lights on rear grille side cover (2)	●
Additional front lights on cab (2)	○
Rear lights on cab (2)	○

POWER TRAIN

Automatic transmission with load sensing system	●
Clutch cut position switch	●
Differential	
TPD (Torque Proportioning Differential)	●
LSD (Limited Slip Differential)	○
DSS (Down Shift Switch)	●
Forward/Reverse lever	●
Power mode switch	●
Quick power switch	●
Travel mode selector (Auto1-Auto2)	●

ENGINE

Air intake	
Rain cap	●
Pre-cleaner (Sy-Klone)	○
Air filter double elements	●
Cartridge-type engine oil filter	●
Cartridge-type fuel filter	●
Engine oil remote drain	●

MONITORING SYSTEM

Gauge: coolant temperature, fuel, transmission oil temperature	●
Indicator lights: air filter restriction, clearance lights, control lever lock, discharge warning, emergency steering, engine warning, fan reverse, forward/reverse selector switch, high beam, hydraulic oil temperature, maintenance, parking brake, power mode, preheat, seat belt, service, transmission oil temperature, transmission warning, turn signals, work lights	●
LCD monitor display: clock, ECO, F-N-R/Shift position, hold, hour meter, odometer, replacement intervals, ride control, speedometer	●
Warning lights: axle oil temperature, brake oil low pressure, engine oil low pressure, overheat, steering oil low pressure	●

BRAKE SYSTEM

Front & rear independent brake circuit	●
Inboard mounted fully hydraulic 4 wheel wet disc	●
Pedal	
Double (LH & RH) brake pedal	●
Single brake pedal	○
Spring-set/Hydraulic-released parking brake	●

HYDRAULIC SYSTEM

Bucket auto leveler (Automatic return to dig control)	●
Control lever	
for 2 spools control valve	
2 levers	●
Multifunction lever (MF lever)	○
for 3 spools control valve	
MF lever & AUX lever for 3rd function	○
2 levers & AUX lever for 3rd function	○
- Outside layout pattern (Bucket - liftarm - 3rd)	○
Control lever lock handle	●
Dual lift arm auto leveler	○
Hydraulic filters	●
Lift arm float system	●
Lift arm kick out	●
Reservoir sight gauge	●
Ride control system (OFF-AUTO type)	○

TIRES

26.5-25-16PR (L3)	●
26.5-25-20PR (L3)	○
26.5-25-20PR (L5)	○
26.5R25 (L3)	○
26.5R25 (L5)	○

MISCELLANEOUS

Articulation lock bar	●
Belly guard (bolt on type) (front / rear frame)	○
Bucket cylinder guard	○
Counterweight	
2 080 kg counterweight	●
2 540 kg counterweight	○
Drawbar with locking pin	●
Emergency steering	○
Fenders	
Front & half covered rear fenders	●
Front & full covered rear fenders with mud flaps	○
Front & half covered rear fenders with mud flaps	○
Global e-service	●
Lift arm	
Standard lift arm	●
High lift arm	○
Lift & tie down hooks	●
On board information controller	●
Anti-vandal protection	
Battery cover with locking bracket	●
Lockable engine cover	●
Lockable fuel refilling cap	●

Standard and optional equipment may vary by country, so please consult your Hitachi dealer for details.



Built on the foundation of superb technological capabilities, Hitachi Construction Machinery is committed to providing leading-edge solutions and services to contribute as a reliable partner to the business of customers worldwide.



Hitachi Environmental Vision 2050

Our Environmental Vision envisions a low-carbon society; a resource efficient society; a harmonized society with nature. To achieve such a sustainable society, we have established a set of long-term environmental targets called Hitachi Environmental Innovation 2050.

Reducing Environmental Impact by New ZW

Hitachi makes a green way to cut carbon emissions for global warming prevention according to LCA*. New ZW utilizes many technological advances, including the new standard mode which optimizes fuel efficiency. Hitachi has long been committed to recycling of components, such as aluminum parts in radiators and oil coolers. Resin parts are marked for recycling.

*Life Cycle Assessment – ISO 14040

Before using a machine with a satellite communication system, please make sure that the satellite communication system complies with local regulations, safety standards and legal requirements. If not so, please make modifications accordingly.

These specifications are subject to change without notice. Illustrations and photos show the standard models, and may or may not include optional equipment, accessories, and all standard equipment with some differences in color and features. Before use, read and understand the Operator's Manual for proper operation.